

# PRICE LIST

1.05.2024



1. Irons and accessories .....	3
2. Semi-Professional ironing tables.....	4
3. ProfesSional Ironing tables.....	13
4. Upsteaming machines.....	25
5. Ironing tables for curtains .....	29
6. Form Finisher .....	33
7. Fusing plate Presses/ fusing machines for transfers.....	35
8. Spotting equipment .....	36
9. Bagging machines.....	38
10. Steam generators.....	40
11. Additional equipment .....	50

## 1. IRONS AND ACCESSORIES

01265A	<p><b>Iron AX250 –Economic line of irons, recommended for Mila steam generator in set with WA-6 or WA-7. Reccomended with Ecomatic line.</b> Complete iron with electric cable, steam hose, electric plunger.</p> <p><b>Price: 85 €</b></p>	
01276K	<p><b>Alux T3</b> elegant industrial iron with ergonomic cork handle for professional use. Suspension mounted on the back of the iron. Recommended for sets: <b>WA-10, WA-17, WA-9</b> Complete iron with electric cable, steam hose, electric plunger</p> <p><b>Price: 225 €</b></p>	
01260A	<p><b>Electric Iron Jolly</b> – popular Iron for industry. cork handle. Complete iron with electric cable, steam hose, electric plunger.</p> <p><b>Price: 195€</b></p>	
01274AP	<p>Electric iron Alux Open – open handle with double micro switch on both sides of handle. Ideal for right and left hand users. Complete iron with electric cable, steam hose, electric plunger.</p> <p><b>Price: On demand</b></p>	
01335B	<p>All Steam Iron – steaming iron without heating element. Equipped for steam hoses, steam trap. No possible to suspense iron.</p> <p><b>Price: 480 €</b></p>	
01404kpl	<p>Smartlemm –Double fuction ligh iron. Can works with Teflon sole or with brush. Perfect to iron curtains connected to ALUX steam generators</p> <p><b>Price: On demand</b></p>	
01400k	<p>Steam brush Speedy – it is like a classic. Electric stam brush for coats.</p> <p><b>Price: 185 €</b></p>	
01372kpl	<p>FR1 Iron – Light iron in type like Hand Finisher. Perfect for la Automotive in connection with steam generator WA-44, and steam heater WA-60</p> <p><b>Price: On demand</b></p>	

## 2. SEMI-PROFESSIONAL IRONING TABLES

80006	WA-6 (vacuum)	450,00 €	<input type="checkbox"/>
80006N	WA-6N (vacuum, blowing)	510,00 €	<input type="checkbox"/>
80006W	WA-6w (vacuum + steam generator 2,5L )	770,00 €	<input type="checkbox"/>
80006R	WA-6R (vacuum, gas spring – easy folding and unfolding of the table)	520,00 €	<input type="checkbox"/>
80006NW	WA-6Nw (vacuum, blowing + steam generator 2,5L)	850,00 €	<input type="checkbox"/>
80006RW	WA-6NRw (vacuum, + steam generator 2,5L ) Gas spring	850,00 €	<input type="checkbox"/>



Available types of boards

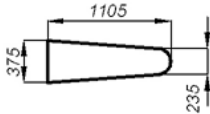

### Ironing table – standard equipment

- Air vacuum
- Air Vacuum, blowing – version 80006N and 80006NW
- Fan motor power 75 W
- Heating board with temperature regulation 30-90 °C
- Board heating power 600 W
- Electric power: 230V/50Hz
- Weight: 23Kg (without steam generator, without ironing form)
- Dimensions of table ready to work 135 x 40 x 85 cm

The new type WA-6R ironing table features vacuum, a heated table surface (temperature regulation from 30-90°C), a shelf under the table, a cable holder, adjustable height, and a foldable base with wheels for easy movement.

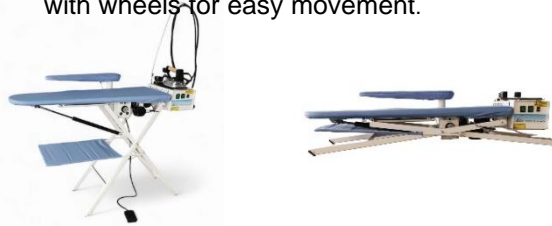

### Steam station:

- Max working pressure: 2,5 bar
- Heating elements: 1,5 kW
- Boiler capacity 2,5 L
- Solenoid valve with regulation: 1 pcs
- Electro-steam iron 800W

### Additional equipment

80029	Ironing form with connection	140 €	<input type="checkbox"/>
01265A	Electric Steam Iron AX250 (Cork Handle) Weight 1,75kg. power: 800W	85 €	<input type="checkbox"/>
05544	Teflon sole plate for iron	12,80 €	<input type="checkbox"/>
71326A	Base (Holder) for Mounting the Ola and Mila Steam Generators to WA-6, WA-7 (instead of the Iron Rest Shelf)		<input type="checkbox"/>

80007w/2,5	<b>WA-7w/2,5L (vacuum+ steam generator 2,5L)</b>	<b>855,00 €</b>	<input type="checkbox"/>
80007Cw/2,5	<b>WA-7Nw/2,5L (vacuum+blowing+steam generator 2,5L)</b>	<b>965,00 €</b>	<input type="checkbox"/>



Dostępne blaty

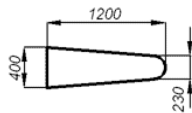

"The photo shows the device along with accessories which are sold separately."

### Ironing Table with Vacuum (WA-7w) and with Vacuum and Blowing in Version (WA-7Nw)

Equipped with a heated table surface (temperature regulation from 30-90°C), a material shelf, cable holder, iron rest, and a foldable base. The perforated table surface is made of aluminum sheet covered with a special 3D material for better steam distribution and improved vacuum-blowing efficiency. The set includes the MILA 2.5L steam generator with a stainless steel boiler, equipped with a solenoid valve for steam quantity regulation, a safety thermostat in case of lack of water in the boiler, and an audible alarm and indicator light signaling water shortage.

The sleeve board with vacuum and 100W electric heating, as well as the electric steam iron, are optional and should be ordered separately.

Ideal for small tailor shops, tailoring service points, pattern rooms, and small laundry service points. Adjustable height from 83 to 93 cm.

Manufacturer – ALUX

The table set with the Mila steam generator includes a base for the generator (the iron rests on the generator).

#### Technical specifications:

- Power supply: 230 V / 50 Hz
- Table heating element power: 600 W
- Steam generator heating element power: 1500 W
- WA-7w fan power: 130 W
- WA-7Nw fan power: 130 W + 75 W
- Total power WA-7w/2.5: 2230 W
- Total power WA-7Nw/2.5: 2350 W
- Weight: WA-7w/2.5: 39 kg
- Weight: WA-7Nw/2.5: 42 kg
- Table dimensions ready for use: 145 x 40 x 85 cm

#### ADDITIONAL EQUIPMENT

80029	Ironing form with connection	140 €	<input type="checkbox"/>
01265A	Electric Steam Iron AX250 (Cork Handle) Weight 1,75kg. power: 800W	85 €	<input type="checkbox"/>
05544	Teflon sole plate for iron	12,80 €	<input type="checkbox"/>
71326A	Base (Holder) for Mounting the Ola and Mila Steam Generators to WA-6, WA-7 (instead of the Iron Rest Shelf)		<input type="checkbox"/>

80007w/5,0	<b>WA-7w/5.0 (vacuum+ steam generator 5,0L.)</b>	1020,00 €	<input type="checkbox"/>
80007Cw/5,0	<b>WA-7Nw/5.0 (vacuum+blowing+steam generator 5L)</b>	1180,00 €	<input type="checkbox"/>



Dostępne blaty

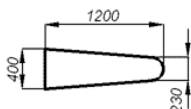

"The photo shows the device along with accessories which are sold separately."

**Ironing table with vacuum (WA-7w)** and with vacuum and blowing in the version (WA-7Nw), equipped with a heated table surface (temperature regulation from 30-90°C). It features a shelf under the table, a cable holder, an iron rest, and a foldable base. The perforated plate on the surface is made of aluminum sheet covered with a special 3D material for better steam distribution and vacuum-blowing efficiency. The set includes the OLA 5L steam generator with a stainless steel boiler equipped with a solenoid valve for steam quantity regulation, a safety thermostat in case of lack of water in the boiler, sound alarm, and water shortage indicator. The sleeve board with vacuum and 100W electric heating, as well as the electric steam iron, are optional and should be ordered separately. Ideal for small tailor shops, tailoring service points, pattern rooms, and small laundry service points. Adjustable height from 83 to 93 cm. Manufacturer - ALUX.

The table set with the Ola steam generator includes a base for the generator (the iron rests on the generator).

#### Technical specifications:

- Table heating element power: 600 W
- Steam generator heating element power: 1500 W
- WA-7w fan power: 130 W
- WA-7Nw fan power: 130 W + 75 W
- Total power WA-7w/5: 2230 W
- Total power WA-7Nw/5: 2305 W
- Weight: WA-7w: 42 kg
- Weight: WA-7Nw: 45 kg
- Table dimensions ready for use: 145 x 40 x 85 cm
- Table dimensions ready for use with sleeve board: 145 x 55 x 85 cm

ADDITIONAL EQUIPMENT			
80029	Ironing form with connection	140 €	<input type="checkbox"/>
01265A	Electric Steam Iron AX250 (Cork Handle) Weight 1,75kg. power: 800W	85 €	<input type="checkbox"/>
05544	Teflon sole plate for iron	12,80 €	<input type="checkbox"/>
71326A	Base (Holder) for Mounting the Ola and Mila Steam Generators to WA-6, WA-7 (instead of the Iron Rest Shelf)		<input type="checkbox"/>

80007	<b>WA-7</b> (vacuum)	515 €	<input type="checkbox"/>
80007C	<b>WA-7N</b> (vacuum+blowing)	655 €	<input type="checkbox"/>



Dostępne blaty

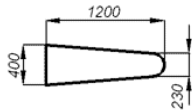

"The photo shows the device along with accessories which are sold separately."

Ironing Table with Vacuum (WA-7) and with Vacuum and Blowing in Version (WA-7N).

Equipped with a heated table surface (temperature regulation from 30-90°C). It includes a material shelf, cable holder, iron rest, and a foldable base. The perforated table surface is made of aluminum sheet covered with a special 3D fabric for better steam distribution and improved vacuum-blowing efficiency. The sleeve board with vacuum and 100W electric heating, as well as the electric steam iron, are optional and should be ordered separately.

Ideal for small tailor shops, pattern rooms, and small laundry service points.

Manufacturer – ALUX

**Technical Specifications:**

- Power supply: 230 V / 50 Hz
- Table heating element power: 600 W
- Fan power (WA-7): 130 W
- Fan power (WA-7N): 130 W + 75 W
- Weight (WA-7): 30 kg
- Weight (WA-7N): 35 kg
- Table dimensions ready for use: 140 x 40 x 88 cm

**ADDITIONAL EQUIPMENT**

80029	Ironing form with connection	140 €	<input type="checkbox"/>
01265A	Electric Steam Iron AX250 (Cork Handle) Weight 1,75kg. power: 800W	85 €	<input type="checkbox"/>
05544	Teflon sole plate for iron	12,80 €	<input type="checkbox"/>
71326A	Base (Holder) for Mounting the Ola and Mila Steam Generators to WA-6, WA-7 (instead of the Iron Rest Shelf)		<input type="checkbox"/>

80007A	<b>WA-7/1 (vacuum)</b>	<b>595,00 €</b>	<input type="checkbox"/>
80007B	<b>WA-7/1N (vacuum+blowing)</b>	<b>695,00 €</b>	<input type="checkbox"/>



Dostępne blaty

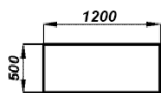

"The photo shows the device along with accessories which are sold separately."

Ironing Table with Rectangular Surface (120x60cm) with Vacuum (WA-7/1) and with Vacuum and Blowing (WA-7/1N)\*\*

Equipped with a heated table surface (temperature regulation from 30-90°C), a cable holder, an iron rest, and a foldable base. The perforated plate on the table surface is made of aluminum sheet covered with a special 3D material for better steam distribution and improved vacuum-blowing efficiency.

The sleeve board with vacuum and 100W electric heating, as well as the electric steam iron, are optional and should be ordered separately.

Ideal for small tailor shops, pattern rooms, and small laundry service points. Adjustable height from 85 to 93 cm.

Manufacturer – ALUX

#### Technical specifications:

- Power supply: 230 V/50 Hz
- Heating element power: 1000 W
- WA-7/1 fan power: 2 x 75 W
- WA-7/1N fan power: 130 W + 75 W
- Weight WA-7/1: 38 kg
- Weight WA-7/1N: 42 kg
- Table dimensions ready for use: 140x60x85 cm

#### ADDITIONAL EQUIPMENT

80029	Ironing form with connection	140 €	<input type="checkbox"/>
01265A	Electric steam Iron AX250 (cork handle) weight 1,75kg. Moc 800W	85 €	<input type="checkbox"/>
05544	Teflon sole plate for iron	12,80 €	<input type="checkbox"/>
71326A	Base (Holder) for Mounting the Ola and Mila Steam Generators to WA-6, WA-7 (instead of the Iron Rest Shelf)		<input type="checkbox"/>

80007AW/2,5	<b>WA-7/1w/2,5 (vacuum+ steam generator 2,5L)</b>	940,00 €	<input type="checkbox"/>
80007BW/2,5	<b>WA-7/1Nw/2,5 (vacuum+blowing+steam generator 2,5L)</b>	1040,00 €	<input type="checkbox"/>



Dostępne blaty

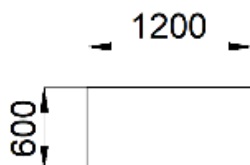

"The photo shows the device along with accessories which are sold separately."

### Ironing Table with Rectangular Surface (120x60cm) with Vacuum (WA-7/1w) and with Vacuum and Blowing (WA-7/1Nw)

Equipped with a heated table surface (temperature regulation from 30-90°C), a cable holder, an iron rest, and a foldable base. The perforated plate on the table surface is made of aluminum sheet covered with a special 3D material for better steam distribution and improved vacuum-blowing efficiency. The set includes the MILA 2.5L steam generator with a stainless steel boiler equipped with a solenoid valve for steam quantity regulation, a safety thermostat in case of lack of water in the boiler, sound alarm, and water shortage indicator.

The sleeve board with vacuum and 100W electric heating, as well as the electric steam iron, are optional and should be ordered separately.

The table is an ideal solution for small tailor shops, tailoring service points, pattern rooms, and small laundry service points.

Manufacturer – ALUX

#### Technical Specifications:

- Heating element power: 1000 W
- Steam generator heating element power: 1500 W
- WA-7/1 fan power: 2 x 75 W
- WA-7/1N fan power: 130 W + 75 W
- Total power WA-7/1w/2.5: 1730 W
- Total power WA-7/1Nw/2.5: 1805 W
- Weight: 45 kg
- Power supply: 230 V / 50 Hz
- Table dimensions ready for use: 140 x 60 x 85 cm

#### ADDITIONAL EQUIPMENT

80029	Ironing form with connection	140 €	<input type="checkbox"/>
01265A	Electric steam Iron AX250 (cork handle) weight 1,75kg. Moc 800W	85 €	<input type="checkbox"/>
05544	Teflon sole plate for iron	12,80 €	<input type="checkbox"/>
71326A	Base (Holder) for Mounting the Ola and Mila Steam Generators to WA-6, WA-7 (instead of the Iron Rest Shelf)		<input type="checkbox"/>



80007AW/5,0	<b>WA-7/1w/5 (vacuum+ steam generator 2,5L)</b>	1 050,00 €	<input type="checkbox"/>
80007BW/5,0	<b>WA-7/1Nw/5 (vacuum+blowing+steam generator 2,5L)</b>	1 150,00 €	<input type="checkbox"/>



Dostępne blaty

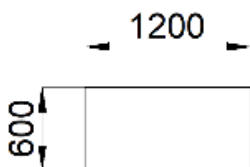

Do zmiany zdjęcie

**Ironing table** with a rectangular surface measuring 120x60cm with vacuum (WA-7/1w) and with vacuum and blowing in the version (WA-7/1Nw), equipped with a heated table surface (temperature regulation from 30-90°C). It features a cable holder, an iron rest, and a foldable base. The perforated plate on the table surface is made of aluminum sheet covered with a special 3D material for better steam distribution and vacuum-blowing efficiency. The set includes the OLA 5L steam generator with a stainless steel boiler equipped with a solenoid valve for steam quantity regulation, a safety thermostat in case of lack of water in the boiler, a water level indicator for water quantity control, sound alarm, and water shortage indicator.

The sleeve board with vacuum and 100W electric heating, as well as the electric steam iron, are optional and should be ordered separately. The table is an ideal solution for small tailor shops, tailoring service points, pattern rooms, and small laundry service points.

Manufacturer - ALUX

#### Technical Specifications:

- Heating element power for the table: 1000 W
- Heating element power for the steam generator: 2000 W
- Fan power for WA-7/1: 2 x 75 W
- Fan power for WA-7/1N: 130 W + 75 W
- Total power for WA-7/1w/5: 3150 W
- Total power for WA-7/1Nw/5: 3205 W
- Weight for WA-7/1w/5: 56 kg
- Weight for WA-7/1Nw/5: 59 kg
- Power supply: 230 V/50 Hz
- Dimensions of the table ready for use: 145x60x85 cm

#### Additional equipment

80029	Ironing form with connection	140 €	<input type="checkbox"/>
01265A	Electric Steam Iron AX250 (Cork Handle) Weight 1,75kg. power: 800W	85,00 €	<input type="checkbox"/>
05544	Teflon sole plate for iron	12,80 €	<input type="checkbox"/>
71326A	Base (Holder) for Mounting the Ola and Mila Steam Generators to WA-6, WA-7 (instead of the Iron Rest Shelf)		<input type="checkbox"/>

8000V	<b>Economic Dry</b> (vacuum)	790,00 €	<input type="checkbox"/>
8000VN	<b>Economic N Dry</b> (vacuum, blowing )	940,00 €	<input type="checkbox"/>

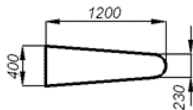

Available types of boards

**Ironing table – standard equipment**

- vacuum (**Economic**)
- vacuum, blowing (**Economic N**)
- heated board with temperature regulation 30-90 °C
- board heating power 600 W
- spring suspension for electric cable and steam hose.
- fan motor power: 130 W (**Economic Dry**)
- fan motor power: 130 W + 75 W (**Economic N Dry**)
- electric power: 230V/50Hz
- electric iron is not included

**Additional equipment**

80029A	Ironing form with connection	165,00 €	<input type="checkbox"/>
01265A	Electric Steam Iron AX250 (Cork Handle) Weight 1,75kg. power: 800W	85,00 €	<input type="checkbox"/>
05544	Teflon sole plate for iron	12,80 €	<input type="checkbox"/>
80052B	Air out tunel	135,00 €	<input type="checkbox"/>
80534	Complete iron shelf	45,00 €	<input type="checkbox"/>
80060A7	Iron suspension mounted to the air tunel (connected with option 80052B)	165 €	<input type="checkbox"/>

80001ECO	<b>Ecomatic</b> (vacuum + boiler built-in + iron)	1690,00 €	<input type="checkbox"/>
80001N-ECO	<b>Ecomatic N</b> (vacuum, blowing + boiler built-in + iron)	1890,00 €	<input type="checkbox"/>



Available types of boards

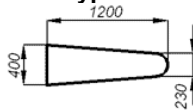

### Ironing table – standard equipment

- vacuum
- vacuum, blowing (**Ecomatic N**)
- heated board with temperature regulation 30-90 °C
- board heating power 600 W
- ironing form with connection WA-101
- spring suspension for electric cable and steam hose.
- boiler built-in – 5 lt (INOX)
- electro-steam output x 1
- boiler heating elements 2.0 kW
- fan motor power: 130 W
- fan motor power: 130 W + 75 W
- pump power (electromagnetic): 47 W
- electric power: 230V/50Hz or 400 V / 50 Hz

### Additional equipment

80029A	Ironing form with connection	165,00 €	<input type="checkbox"/>
01265A	Electric Steam Iron AX250 (Cork Handle) Weight 1,75kg. power: 800W	85,00 €	<input type="checkbox"/>
05544	Teflon sole plate for iron	12,80 €	<input type="checkbox"/>
80052B	Air out tunel	135,00 €	<input type="checkbox"/>
80534	Complete iron shelf	45,00 €	<input type="checkbox"/>
80060A7	Iron suspension mounted to the air tunel (connected with option 80052B)	165 €	<input type="checkbox"/>

### 3. PROFESSIONAL IRONING TABLES

80001

**WA-1 (vacuum)**

890,00 €



Available types of boards

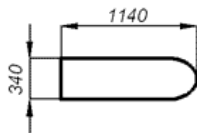

**Ironing table WA-1** with strong suction, heated surface (temperature regulation from 30-90°C), and switching between suction and ironing modes. The perforated plate on the surface is made of aluminum sheet covered with aluminum mesh for better steam distribution and suction efficiency. It features stepwise height adjustment from 80 to 95 cm (every 5 cm), an iron rest, a cable holder, and a material shelf. The device is compatible with mounting any Alux ironing form. Sleeve board with suction and 100W electric heating, as well as other forms, must be ordered separately.

Manufacturer - ALUX

**Technical specifications:**

- Heating element power: 600 W
- Fan power: 370 W
- Power supply: 230 V / 50 Hz or 400 V / 50 Hz
- Weight: 54 kg
- Dimensions of the table ready for use: 140x40x90 cm

**Additional equipment**

80021	Ironing form	130,00 €	<input type="checkbox"/>
<b>80081BN</b>	Connection 500 mm for ironing form (forms to choose on pages 45-49) (instead of 80021A)	120,00 €	<input type="checkbox"/>
80051	Air blow-out tunnel	150,00 €	<input type="checkbox"/>
80066	Lighting (requires 80051 or 80061)	145,00 €	<input type="checkbox"/>
80060	Iron suspension (needed 80051 or 80061)	170,00 €	<input type="checkbox"/>
80080A	Height regulation (85 – 95 cm)	170,00 €	<input type="checkbox"/>

80005A	<b>WA-5 (vacuum)</b>	930,00 €	<input type="checkbox"/>
80005B	<b>WA-5 (vacuum)</b>		



**Ironing table WA-5 – standard equipment**

- air vacuum
- heated board with temperature regulation 30-90 °C
- spring suspension for electric cable and steam hose.
- fan motor power 550 W
- board heating power: 1000 W
- electric power: 230 V / 50 Hz or 400 V / 50 Hz

80005A – board A  
80005B – board B

**Available types of boards**

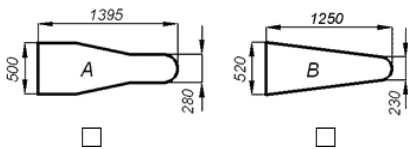

**Board direction**

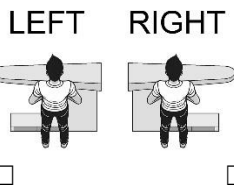

<b>Additional equipment</b>			
80021	Ironing form	130,00 €	<input type="checkbox"/>
<b>80081BN</b>	Connection 500 mm for ironing form (forms to choose on pages 45-49) (instead of 80021A)	120,00 €	<input type="checkbox"/>
80051	Air blow-out tunnel	150,00 €	<input type="checkbox"/>
80066	Lighting (requires 80051 or 80061)	145,00 €	<input type="checkbox"/>
80060	Iron suspension (needed 80051)	170,00 €	<input type="checkbox"/>
80080A	Height regulation (85 – 95 cm)	175,00 €	<input type="checkbox"/>

80003VA  
 80003VB

**WA-3V** (vacuum + blowing) Board A  
**WA-3V** (vacuum + blowing) Board B

2070,00 €



Available types of boards

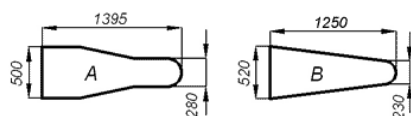

Board direction

LEFT      RIGHT

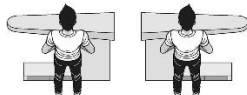
**Ironing table WA-3 – standard equipment**

- air vacuum and blowing
- heated board with temperature regulation 30-90 °C
- automatic switching-over vacuum/blowing – board/ironing form
- perforated plate on the table top made of aluminum sheet with aluminum mesh for better steam distribution and vacuum – blowing efficiency
- standard version includes manual height regulation of the table top- possible height 82-92 cm.
- regulated base for iron
- spring suspension for electric cable and steam hose.
- possibility to install two ironing forms
- possibility of transfer of the pedals to the other side.
- funnel with electrical control
- metal shelf located under board
- fan motor power 550 W
- board heating power: 1000 W
- electric power: 230 V / 50 Hz or 400 V / 50 Hz
- **Regulation of height (85 – 95 cm)**

By means of exhaust air chimney (optional), it is possible to regulate vacuum/ blow.

 80003VA – board A  
 80003VB – board B

**Additional equipment**

80021A1	Ironing form with connection for WA-3V (aluminium)	390,00 €	<input type="checkbox"/>
<b>80021A1N</b>	Ironing form with connection for WA-3V (steel) (instead of 80021A1)	290,00 €	<input type="checkbox"/>
80066	Lighting	145,00 €	<input type="checkbox"/>
80060	Iron suspension (needed 80051 or 80061)	170,00 €	<input type="checkbox"/>
80051	Air funnel	150,00 €	<input type="checkbox"/>
80088	Arm to ironing hanging clothes	88,00 €	<input type="checkbox"/>
80038	Spotting arm – form for cold cleaning	280,00 €	<input type="checkbox"/>
80542	Finishing gun kit	242,00 €	<input type="checkbox"/>

80002A* 80002B** 80002C***	<b>WA-2 (vacuum)</b>	1060,00 €	<input type="checkbox"/>
80002w	<b>WA-2w (vacuum + boiler built-in)</b>	2080,00 €	<input type="checkbox"/>



### Ironing table WA-2 – standard equipment

- air vacuum
- heated board with temperature regulation 30-90 °C
- spring suspension for electric cable and steam hose.
- fan motor power 550 W
- board heating power: 1000 W
- electric power: 230 V / 50 Hz or 400 V / 50 Hz

### WA-2w – boiler specification

- boiler capacity: 6 L (INOX)
- pump motor power: 370 W
- heating elements of boilers: 3000 W
- maximum working pressure: 3,5 bar
- electro-steam output x 1

### Available types of boards

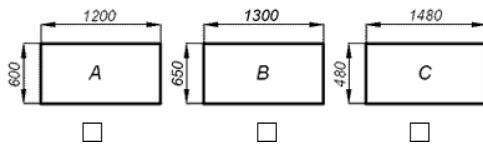

80002A – board A  
 80002B – board B  
 80002C – board C

### Additional equipment

80081BN	Connection 500 mm for ironing form	120,00 €	<input type="checkbox"/>
80081CN	Connection 600 mm for Ironing form	130,00 €	<input type="checkbox"/>
80081DN	Connection 800 mm for Ironing form	150,00 €	<input type="checkbox"/>
80052	Right side air blow-out tunnel	220,00 €	<input type="checkbox"/>
80052A	Rear air blow-out tunnel	220,00 €	<input type="checkbox"/>
80066	Lighting (needs 80052)	145,00 €	<input type="checkbox"/>
80066B	Lighting (needs 80052A)	145,00 €	<input type="checkbox"/>
80060	Iron suspension for 80052	170,00 €	<input type="checkbox"/>
80060C	Iron suspension for 80052A	170,00 €	<input type="checkbox"/>
80080A	Height regulation (85 – 95 cm) – gas spring	180,00 €	<input type="checkbox"/>

80004R* 80004B** 80004C***	<b>WA-4</b> (vacuum + blowing )	2080,00 €	<input type="checkbox"/>
80004w	<b>WA-4w</b> (vacuum + blowing + boiler built-in)	3100,00 €	<input type="checkbox"/>



#### Ironing table WA-4 – standard equipment

- air vacuum and blowing
- heated board with temperature regulation 30-90 °C
- spring suspension for electric cable and steam hose.
- fan motor power 550 W
- board heating power: 1000 W
- electric power: 230 V / 50 Hz or 400 V / 50 Hz

#### WA-4w – boiler specification

- boiler capacity: 6 L (INOX)
- pump motor power: 370 W
- boiler heating elements: 3000 W
- maximum working pressure: 3,5 bar
- electro-steam output x 1

#### Available types of boards

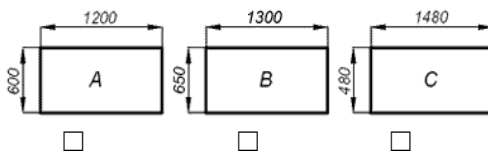

- 80004R – board A  
 80004B – board B  
 80004C – board C

#### Additional equipment

80081BN	Connection 500 mm for ironing form	120,00 €	<input type="checkbox"/>
80081CN	Connection 600 mm for Ironing form	130,00 €	<input type="checkbox"/>
80081DN	Connection 800 mm for Ironing form	150,00 €	<input type="checkbox"/>
80052	Right side air blow-out tunnel	220,00 €	<input type="checkbox"/>
80052A	Rear air blow-out tunnel	220,00 €	<input type="checkbox"/>
80066	Lighting (needs 80052)	145,00 €	<input type="checkbox"/>
80066B	Lighting (needs 80052A)	145,00 €	<input type="checkbox"/>
80060	Iron suspension for 80052	170,00 €	<input type="checkbox"/>
80060C	Iron suspension for 80052A	170,00 €	<input type="checkbox"/>
80080A	Height regulation (85 – 95 cm) – gas spring	180,00 €	<input type="checkbox"/>



80008\*  
 80008B\*\*

**WA-8 (vacuum + boiler built-in)**

2690,00 €

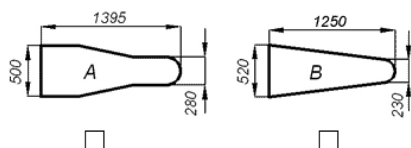
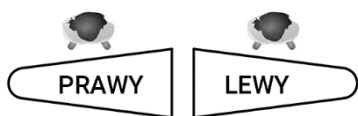
**Available types of boards**

**Board direction**

**Right**
**Left**
**Ironing table – standard version**

- air vacuum
- boiler built-in – 7.2 lt (INOX)
- heated board with temperature regulation 30-90 °C
- board heating power 1000 W with regulation
- spring suspension for electric cable and steam hose
- automatic switching-over vacuum – board/ironing form (pneumatic or electric)
- regulated base for iron
- arm for ironing hanging cloths
- spring suspension for electric cable and steam hose.
- metal shelf located under board
- electro-steam output x 1
- boiler heating elements 3000 W or 4200 W
- fan motor power 550 W
- working steam pressure 4,5 bar
- pump power 500 W.
- electric power: 230 V / 50 Hz or 400 V / 50 Hz
- required air pressure 6-10 bar (pneumatic version)

 80008 – board A  
 80008B – board B

**Additional equipment**

80021A	Ironing WA-101 form with connection (aluminium)	378,00 €	<input type="checkbox"/>
80021AN	Ironing WA-101 form with connection (steel) (instead of 80021A)	270,00 €	<input type="checkbox"/>
80066	Lighting	145,00 €	<input type="checkbox"/>
80060	Iron suspension	170,00 €	<input type="checkbox"/>
01200kpl	Electro-steam iron	195,00 €	<input type="checkbox"/>
01276K	Electro-steam iron T3 – <b>Premium</b>	225,50 €	<input type="checkbox"/>
01327	All Steam iron	470,00 €	<input type="checkbox"/>
01520	Air-steam gun (needs 80048)	95,00 €	<input type="checkbox"/>
80049	Additional electro-steam output	136,00 €	<input type="checkbox"/>
80048	Air - steam output for gun	180,00 €	<input type="checkbox"/>
01400K	Electro-steam brush (needs 80049)	185,00 €	<input type="checkbox"/>
80542	Finishing gun kit (spotting gun with equipment)	265,00 €	<input type="checkbox"/>
70064	Water tank 17 L made of inox	230,00 €	<input type="checkbox"/>
80088	Arm to ironing hanging cloths	90,00 €	<input type="checkbox"/>
80038	Form for cold cleaning	280,00 €	<input type="checkbox"/>
80079C	Regulation of height	190,00 €	<input type="checkbox"/>
80072	Double side switch pedals	170,00 €	<input type="checkbox"/>
01506A	Water spray gun kit	130,00 €	<input type="checkbox"/>
60005A	Iron cables cover	24,00 €	<input type="checkbox"/>

**Additional equipment**

80059	Rotating, adjustable iron support	180,00 €	<input type="checkbox"/>
.....	Teflon shoe	12,80 €	<input type="checkbox"/>

80010\*  
 80010B\*\*

**WA-10N** (vacuum + blowing + boiler built-in)

3890,00 €



Available types of boards

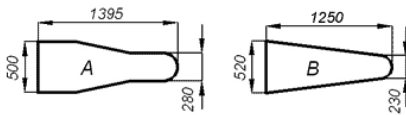

Board direction

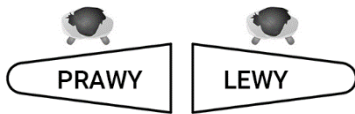

Right

Left

**Ironing table – standard version**

- air vacuum and blowing
- boiler built-in – 7.2 lt (INOX)
- heated board with temperature regulation 30-90 °C
- board heating power 1000 W with regulation
- spring suspension for electric cable and steam hose
- automatic switching-over vacuum – board/ironing form (pneumatic or electric)
- regulated base for iron
- arm for ironing hanging cloths
- metal shelf located under board
- electro-steam output x 1
- boiler heating elements 3000 W or 4200 W
- fan motor power 550 W
- working steam pressure 4,5 bar
- pump power 500 W.
- electric power: 230 V / 50 Hz or 400 V / 50 Hz
- required air pressure 6-10 bar (pneumatic version)

 80010 – board A  
 80010B – board B

**Additional equipment**

80021A	Ironing form with connection	380,00 €	<input type="checkbox"/>
80021AN	Ironing WA-101 form with connection (steel) (instead of 80021A)	270,00 €	<input type="checkbox"/>
80066	Lighting	145,00 €	<input type="checkbox"/>
80060	Iron suspension	170,00 €	<input type="checkbox"/>
01200kpl	Electro-steam iron	195,00 €	<input type="checkbox"/>
01276K	Electro-steam iron T3 – <b>Premium</b>	225,50 €	<input type="checkbox"/>
01327	All Steam iron	470,00 €	<input type="checkbox"/>
01520	Air-steam gun (needs 80048)	95,00 €	<input type="checkbox"/>
80049	Additional electro-steam output	136,00 €	<input type="checkbox"/>
80048	Air - steam output for gun	180,00 €	<input type="checkbox"/>
01400K	Electro-steam brush (needs 80049)	185,00 €	<input type="checkbox"/>
80542	Finishing gun kit (spotting gun with equipment)	265,00 €	<input type="checkbox"/>
70064	Water tank 17 L made of inox	230,00 €	<input type="checkbox"/>
80088	Arm to ironing hanging cloths	90,00 €	<input type="checkbox"/>
80038	Form for cold cleaning	280,00 €	<input type="checkbox"/>
80079C	Regulation of height	190,00 €	<input type="checkbox"/>
80072	Double side switch pedals	170,00 €	<input type="checkbox"/>
01506A	Water spray gun kit	130,00 €	<input type="checkbox"/>
60005A	Iron cables cover	24,00 €	<input type="checkbox"/>

Additional equipment			
80059	Rotating, adjustable iron support	180,00 €	<input type="checkbox"/>
.....	Teflon shoe	12,80 €	<input type="checkbox"/>

80010E

**WA-17** (vacuum + blowing + boiler built-in)

4450 €

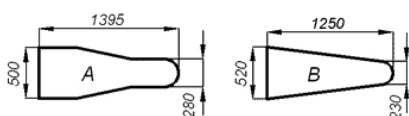
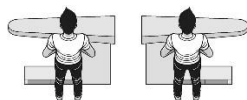

"The photo shows the device along with accessories which are sold separately."

**Board Version**
**LEFT    RIGHT**

**Suction and Air Blowing:** Equipped with both suction and air blowing functionalities.

**Built-in Automatic Steam Generator:** Includes an integrated steam generator.

**Heated Tabletop:** Adjustable temperature control ranging from 30°C to 90°C.

**Automatic Switching:** Automatic switching between suction/blowing and from the table to the pressing form.

**Perforated Plate:** The tabletop features a perforated plate covered with an aluminum mesh for better steam distribution and suction efficiency.

**Cable Holder:** Includes a holder for suspending cables to keep the workspace tidy.

**Integrated Lighting:** Built-in lighting for better visibility and working conditions.

**Metal Shelf:** Comes with a metal shelf for storing materials, making it easier to manage your work.

**Photoelectric Sensor:** Standard control of suction via a photoelectric sensor.

**Suction/Blowing Regulation:** Adjustable suction and blowing functions.

**Iron Cable Holders:** Equipped with holders for iron cables.

**Technical Specifications:**

- Heating element power: 1000 W
- Fan power: 550 W
- Power supply: 230 V / 50 Hz or 400 V / 50 Hz
- Boiler capacity: 7.2 L
- Centrifugal pump power: 500 W
- Boiler heating elements power: 3000 W or 4200 W
- Maximum operating steam pressure: 4.5 bar
- Single electrical-steam outlet
- Required air pressure: 6-10 bar

**Additional equipment**

80021A	Ironing form with connection	380,00 €	<input type="checkbox"/>
80060	Iron suspension (only with electric iron)	170,00 €	<input type="checkbox"/>
80049	Additional electro - steam output	140,00 €	<input type="checkbox"/>
01400K	Speedy Iron brush (needs 80049)	185,00 €	<input type="checkbox"/>
80048	Air - steam output for gun	180,00 €	<input type="checkbox"/>
01520	Air-steam gun (needs 80048)	98,00 €	<input type="checkbox"/>
80542	Finishing gun kit (spotting gun with equipment)	245,00 €	<input type="checkbox"/>
70046	Water tank 17 L made of inox	230,00 €	<input type="checkbox"/>
80088	Arm for ironing hanging cloths	90,00 €	<input type="checkbox"/>
80038	Form for cold cleaning	280,00 €	<input type="checkbox"/>
80080B	Electric regulation of height – very easy to use	580,00 €	<input type="checkbox"/>
80620	Side covers	220,00 €	<input type="checkbox"/>
80071	Double side switch pedals and photocell	230,00 €	<input type="checkbox"/>
80059	Rotating, adjustable iron support	180,00 €	<input type="checkbox"/>
01260A	Jolly Iron - complete	195,00 €	<input type="checkbox"/>
01327	Jolly Electronic temperature setting	480,00 €	<input type="checkbox"/>
01327	All Steam Iron	480,00 €	<input type="checkbox"/>

80009	<b>WA-9</b> (vacuum, upsteaming, external steam source)	2900,00 €	<input type="checkbox"/>
80009W	<b>WA-9w</b> (vacuum, upsteaming boiler built-in)	3970,00 €	<input type="checkbox"/>
80009N	<b>WA-9N</b> (vacuum, blowing, upsteaming, external steam source)	3970,00 €	<input type="checkbox"/>
80009NW	<b>WA-9Nw</b> (vacuum, blowing, upsteaming, boiler built-in)	4850,00 €	<input type="checkbox"/>

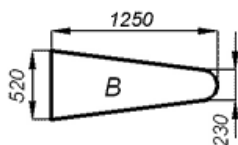

Version with lighting without cover

**Available types of boards**

**Board direction**

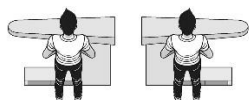
LEFT    RIGHT

**Ironing table – standard version**

- air vacuum and blowing: **WA-9N, WA-9Nw**
- air vacuum: **WA-9, WA-9w**
- **Upsteaming – ALL VERSIONS**
- boiler built-in – 8 lt (INOX): **WA-9Nw, WA-9w**
- heated board by the steam
- spring suspension for electric cable and steam hose
- automatic switching-over vacuum – board/ironing form (pneumatic or electric)
- regulated base for iron
- metal shelf located under board
- electro-steam output x 1
- boiler heating elements 6000 W or 8400 W
- fan motor power 550 W
- working steam pressure 4,5 bar
- pump power 500 W (only version with boiler built-in)
- electric power: 230 V / 50 Hz or 400 V / 50 Hz
- required air pressure 6-10 bar
- board height: 90 cm



Version with covered light and with side covers

**Additional equipment**

80021A	Ironing form with connection	380,00 €	<input type="checkbox"/>
80066	Lighting	170,00 €	<input type="checkbox"/>
80067C	Built-in lighting for WA-9 tables	320,00 €	<input type="checkbox"/>
80060	Iron suspension (only with electric iron)	170,00 €	<input type="checkbox"/>
80049	Additional electro - steam output	140,00 €	<input type="checkbox"/>
01400K	Speedy Iron brush (needs 80049)	185,00 €	<input type="checkbox"/>
80048	Air - steam output for gun	180,00 €	<input type="checkbox"/>
01520	Air-steam gun (needs 80048)	98,00 €	<input type="checkbox"/>
80542	Finishing gun kit (spotting gun with equipment)	245 €	<input type="checkbox"/>
70046	Water tank 17 L made of inox	230 €	<input type="checkbox"/>
80088	Arm for ironing hanging cloths	90 €	<input type="checkbox"/>
80038	Form for cold cleaning	280 €	<input type="checkbox"/>
80059	Rotating, adjustable iron support	180 €	<input type="checkbox"/>
80620	Side covers	220 €	<input type="checkbox"/>

Additional equipment			
80072C	Double side switch pedals (80009N i 80009Nw)	230 €	<input type="checkbox"/>
01260A	Jolly Iron - complete	195 €	<input type="checkbox"/>
01327	Jolly Electronic temperature setting	480 €	<input type="checkbox"/>
01327	All Steam Iron	480 €	<input type="checkbox"/>

## 4. UPSTEAMING MACHINES

**WA-12** (vacuum, up steaming, external steam source)

80012S	▪ <b>blat A</b> (1800 x 900mm)	3890,00 €	<input type="checkbox"/>
80012SB	▪ <b>blat B</b> (2000 x 900mm)	4190,00 €	<input type="checkbox"/>
80012SC	▪ <b>blat C</b> (2000 x 1000mm)	4290,00 €	<input type="checkbox"/>

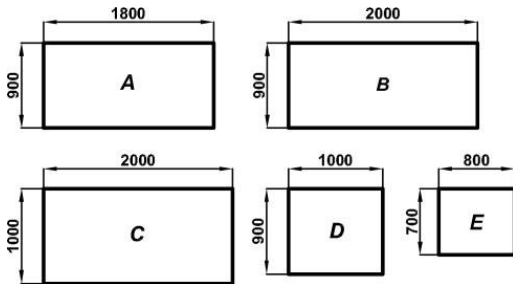
**Available types of boards**

**Table with up steaming function**

The rectangular steam ironing table has been specially conceived for stabilization of knitwear and clothes that may not be ironed on press or with iron. The uniform steam inflow, heated up plate, vacuum on entire surface assure an excellent stabilization of articles. The table is simple to use: by means of two foot pedals, placed in a table base. The inclination of ironing board makes the positioning of articles easier and reduces operator's effort.

The device is equipped with operating mode switch: manual/ semi manual operating mode (there is possibility to set up vacuum and steaming time parameters).

**Perfect distribution of steam in the up steaming board**

- Power supply: 230 V / 50 Hz lub 400 V / 50 Hz
- Fan motor power: 370 W
- Working pressure: 4,5 bar

**Additional equipment**

80047A	Electro-steam output for iron	230 €	<input type="checkbox"/>
	Steam trap	on demand	<input type="checkbox"/>



WA-12w (vacuum, up steaming boiler built-in)			
80012W	▪ <b>Board A</b> (1800 x 900mm, boiler 21 L, heating power 12–15 kW)	6200,00 €	<input type="checkbox"/>
80012WB	▪ <b>Board B</b> (2000 x 900mm, boiler 21 L, heating power 12–15 kW)	6500,00 €	<input type="checkbox"/>
80012WC	▪ <b>Board C</b> (2000 x 1000mm, boiler 21 L, heating power 15–18 kW)	6800,00 €	<input type="checkbox"/>



Available types of boards

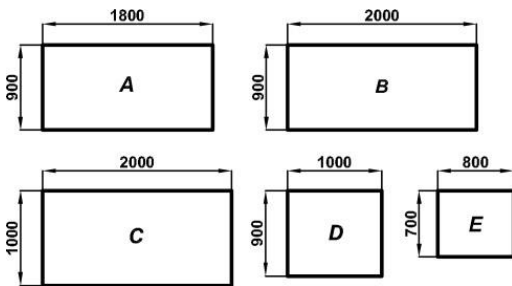

### Table with evaporation

The rectangular steam ironing table has been specially conceived for stabilization of knitwear and clothes that may not be ironed on press or with iron. The uniform steam inflow, heated up plate, vacuum on entire surface assure an excellent stabilization of articles. The table is simple to use: by means of two foot pedals placed in a table base. The inclination of ironing board makes the positioning of articles easier and reduces operator's effort.

The device is equipped with operating mode switch: manual/ semi manual operating mode (there is possibility to set up vacuum and steaming time parameters).

- Power supply: 230 V / 50 Hz lub 400 V / 50 Hz
- Fan motor power: 370 W
- Pump power: 500 W
- Working pressure: 4,5 bar
- Heating elements:
  - 8.4 / 12 / 15 / 18 kW
- Boiler capacity 9.8 / 15 / 21 L

### Additional options

80047A	Electro-steam output for iron	220 €	<input type="checkbox"/>
--------	-------------------------------	-------	--------------------------

80019	<b>WA-30/1</b> (vacuum, up steaming boiler built-in)	2830,00 €	<input type="checkbox"/>
80019BW	<b>WA-30/1 BW</b> (vacuum, up steaming, external steam source)	2160,00 €	<input type="checkbox"/>



Customised types of forms



### Special- purpose machine with output for one (1) up steaming form.

Perfect distribution of the steam. Machine is conceived for hats, berets, hats stabilization. The device equipped with ironing form vacuum, heating and steaming and manufactured with built-in steam generator or with connection to an external steam source. The special - purpose machine can work with different shapes and sizes of customized forms, manufactured on individual demand. Stabilization forms are heated electrically. The steam boiler is made of a stainless steel.

### Special – purpose machine with output for one (1) form

- Power supply: 230 V / 50 Hz lub 400 V / 50 Hz
- Fan motor power: 180 W
- Heating power on form 600 W
- Working pressure: 4,5 bar
- Pump power: 500 W (**Wa-30/1**)
- Heating element in boiler 4200 W (**Wa-30/1**)
- Boiler capacity: 7,2 L

### Additional options

Prices of form (depends of shape and dimension)

from 280 € /pcs.



80019A	<b>WA-30/2</b> (vacuum, up steaming boiler built-in)	3100,00 €	<input type="checkbox"/>
80019ABW	<b>WA-30/2 BW</b> (vacuum, up steaming, external steam source)	2430,00 €	<input type="checkbox"/>



Customised types of forms



**Special - purpose machine with output for two (2) up steaming forms.**

Perfect distribution of the steam. Machine is conceived for hats, berets, hats stabilization. The device equipped with ironing form vacuum, heating and steaming and manufactured with built-in steam generator or with connection to an external steam source. The special - purpose machine can work with different shapes and sizes of customized forms, manufactured on individual demand. Stabilization forms are heated electrically.

The steam boiler is made of a stainless steel.

- **Connection for form – 2 outputs**
- Power supply: 230 V / 50 Hz lub 400 V / 50 Hz
- Fan motor power: 2 x 180 W
- Heating power on form 2 x 600 W
- Working pressure: 4,5 bar
- Pump power: 500 W (**Wa-30/1**)
- Heating element in boiler 4200 W (**Wa-30/1**)
- Boiler capacity: 7,2 L

**Additional options**

Customized forms (depend of shape and dimension)

from 280 € /pcs



## 5. IRONING TABLES FOR CURTAINS

<b>WA-2/1 (vacuum) 600mm</b>			
80002/1A	▪ <b>blat A</b> (1600 x 600 mm)	1 400,00 €	<input type="checkbox"/>
80002/1B	▪ <b>blat B</b> (1800 x 600 mm)	1 550,00 €	<input type="checkbox"/>
80002/1C	▪ <b>blat C</b> (2000 x 600 mm)	1 600,00 €	<input type="checkbox"/>
80002/1E	▪ <b>blat E</b> (2500 x 600 mm)	2 250,00 €	<input type="checkbox"/>
80002/1F	▪ <b>blat F</b> (3000 x 600 mm)	2 600,00 €	<input type="checkbox"/>



### Ironing table – standard equipment

- air vacuum
- board temperature regulation
- heated board with temperature regulation 30-90 °C
- pockets for fabric from the front and rear

For tables with E or F board we recommend installing WA-60 steam heater (as additional equipment) for better steam performances.

### Producent – ALUX

#### Technical Specifications

- Power Supply: 230 V / 50 Hz or 400 V / 50 Hz
- Heating Element Power:  
A, B, C: 2 x 1000 W  
E, F: 3 x 1000 W
- Fan Power:  
A, B, C: 260 W  
E: 390 W  
F: 520 W
- Table Height: 90 cm

#### Availabe boards

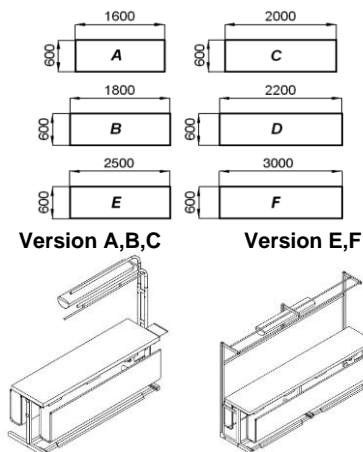

### ADDITIONAL EQUIPMENT

80060A1	Iron suspension for A, B, C version	260,00 €	<input type="checkbox"/>
80060A3	Iron suspension for E, F version	390,00 €	<input type="checkbox"/>
80066A	Ligting (requires iron suspension)	140,00 €	<input type="checkbox"/>
80040	Steam Heater WA-60 – recomend to E,F versions	500,00 €	<input type="checkbox"/>

WA-2/1 (vacuum) 600mm – automatic steam generator			
80002/1Aw	▪ blat A (1600 x 600 mm) + steam generator	2 450,00 €	<input type="checkbox"/>
80002/1Bw	▪ blat B (1800 x 600 mm) + steam generator	2 550,00 €	<input type="checkbox"/>
80002/1Cw	▪ blat C (2000 x 600 mm) + steam generator	2 600,00 €	<input type="checkbox"/>
80002/1Ew	▪ blat E (2500 x 600 mm) + steam generator	3 250,00 €	<input type="checkbox"/>
80002/1Fw	▪ blat F (3000 x 600 mm) + steam generator	3 600,00 €	<input type="checkbox"/>



### Ironing table – standard equipment

- air vacuum
- board temperature regulation
- heated board with temperature regulation 30-90 °C
- pockets for fabric from the front and rear

For tables with E or F board we recommend installing WA-60 steam heater (as additional equipment) for better steam performances.

### Producent – ALUX

#### Technical Specifications

- Power Supply: 230 V / 50 Hz or 400 V / 50 Hz
- Heating Element Power:  
A, B, C: 2 x 1000 W  
E, F: 3 x 1000 W
- Fan Power:  
A, B, C: 260 W  
E: 390 W  
F: 520 W
- Table Height: 90 cm

#### Available boards

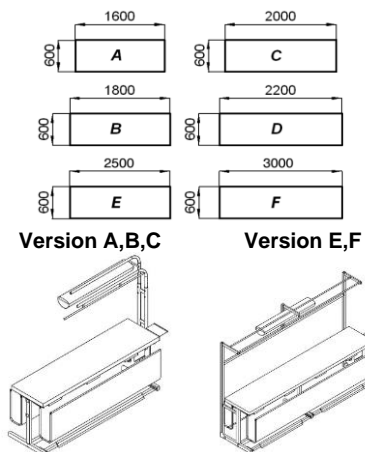

### ADDITIONAL EQUIPMENT

80060A1	Iron suspension for A, B, C version	260,00 €	<input type="checkbox"/>
80060A3	Iron suspension for E, F version	390,00 €	<input type="checkbox"/>
80066A	Ligting (requires iron suspension)	140,00 €	<input type="checkbox"/>
80040	Steam Heater WA-60 – recomend to E,F versions	500,00 €	<input type="checkbox"/>

WA-2/1 (vacuum) 800mm width			
80002/2A	▪ blat A (1600 x 800 mm)	1600 €	<input type="checkbox"/>
80002/2B	▪ blat B (1800 x 800 mm)	1700 €	<input type="checkbox"/>
80002/2C	▪ blat C (2000 x 800 mm)	1800 €	<input type="checkbox"/>
80002/2E	▪ blat E (2500 x 800 mm)	2450 €	<input type="checkbox"/>
80002/2F	▪ blat F (3000 x 800 mm)	2750 €	<input type="checkbox"/>



### Ironing table – standard equipment

- air vacuum
- board temperature regulation
- heated board with temperature regulation 30-90 °C
- pockets for fabric from the front and rear

For tables with E or F board we recommend installing WA-60 steam heater (as additional equipment) for better steam performances.

### Producent – ALUX

#### Technical Specifications

- Power Supply: 230 V / 50 Hz or 400 V / 50 Hz
- Heating Element Power:  
A, B, C: 2 x 1000 W  
E, F: 3 x 1000 W
- Fan Power:  
A, B, C: 260 W  
E: 390 W  
F: 520 W
- Table Height: 90 cm

#### Available boards

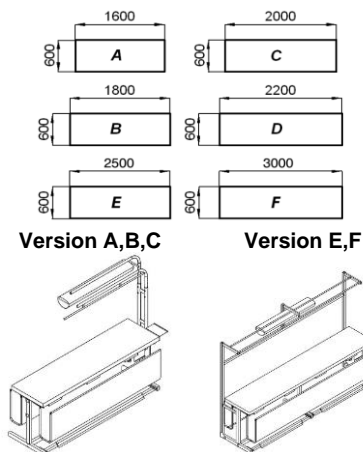

### ADDITIONAL EQUIPMENT

80060A1	Iron suspension for A, B, C version	260,00 €	<input type="checkbox"/>
80060A3	Iron suspension for E, F version	390,00 €	<input type="checkbox"/>
80066A	Ligting (requires iron suspension)	140,00 €	<input type="checkbox"/>
80040	Steam Heater WA-60 – recomend to E,F versions	500,00 €	<input type="checkbox"/>

80002/18	<b>WA-18</b> (vacuum + conveyor belt)	8200,00 €	<input type="checkbox"/>
80002/18N	<b>WA-18N</b> (vacuum + blowing conveyor belt)	8800,00 €	<input type="checkbox"/>



Available board

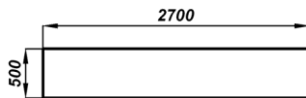

**Special - purpose** ironing table, with big dimensions heated board, conceived for ironing of curtains.

WA-18 special – purpose table is equipped with vacuum (**WA-18 model**) or vacuum /blowing system (**WA-18 N**), heated board with temperature control (from 30<sup>o</sup> C – 90<sup>o</sup> C) and automatic fabric sliding forwards or backwards.

The presence of adjustable pockets situated on both sides of table facilitates the folding of ironed elements.

The WA-18 special –purpose table can be matched with each steam generator and with each electro-steam iron.

Due to the length of steam hose (because of board dimensions) we recommend using the steam heater (as additional equipment) for better steam performances.

- Power supply: 230 V / 50 Hz or 400 V / 50 Hz
- Heating elements: 3000 W
- Motor fan power:
  - WA-18: 3 x 130 W
  - WA-18N: 6 x 130 W
- Sliding motor power: 370 W
- Board height: 90 cm

#### Additional options

80060A4	Iron suspension	450 €	<input type="checkbox"/>
80066C	Lighting – needs iron suspension	140 €	<input type="checkbox"/>
80040	Steam heater WA-60	500 €	<input type="checkbox"/>

## 6. FORM FINISHER

<b>WA-35 (blowing, up steaming, boiler built-in)</b>			
80020A	▪ 12 kW / 17,5 L	5490,00 €	<input type="checkbox"/>
80020B	▪ 15 kW / 17,5 L	5490,00 €	<input type="checkbox"/>



### Steam form finisher – universal

- Rotating body
- Boiler capacity: 9 L or 17,5 L
- Heating elements: 8kW / 12kW / 15kW
- Fan blower: 750W (1HP)
- Pump motor power: 500 W
- Working pressure: 4,5 bar
- Manual or automatic control with time set-up function
- Power supply: 400 V/ 50 Hz

70040	<b>WA-501 (blowing, up steaming, boiler built in)</b>	Price on demand	<input type="checkbox"/>
-------	---	-----------------	--------------------------



Form Finisher for ironing all types of clothes. Connected to external steam supply. Automatic positioning according with clothes length. Can works in three cycles automatic/semi-automatic/manual

- Power supply: 400 V / 50 Hz
- Fan blower: 1100W
- Steam pressure: 5 – 6 bar
- Required air pressure: 7 – 8 bar
- Electric steam heater: 900W



70040

**WA-502** (blowing, up- steaming, Boiler built in)  
price on demandprice on  
demand

Form Finisher for ironing all types of clothes. Connected to external steam supply. Automatic positioning according with clothes length. Operating mode selection: automatic/semi-automatic/manual

- Power supply: 400 V / 50 Hz
- Fan blower: 1100W
- Steam pressure: 5 – 6 bar
- Required air pressure: 7 – 8 bar
- Steam boiler 9 L – 12kW
- Electric steam heater 900W

## 7. FUSING PLATE PRESSES/ FUSING MACHINES FOR TRANSFERS

85010

**WA-14**

2300,00 €



Available board

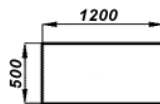

**Fusing plate press** WA-14 is conceived for a contact bonding of a fleece to a previously prepared fabric. It is also used to thermofixing of decorations (inscriptions, leathers) as well as to ironing of simple elements of leather.

- Power supply: 230 V / 50 Hz or 400 V / 50 Hz
- Heating elements: 3000 W
- Electronic temperature regulation: 30 – 250°C
- Maximum pressure: 400 g/m<sup>2</sup> – can be regulated
- Top board made of aluminium casting
- Buzzer informing about the end of set up time

## Additional options

85030

Folded stand

140,00 €



85010A

**WA-14/2 (pneumatic version)**

3100,00 €



**Press for adhesive** and thermal transfer printing – pneumatic version.

- Power supply: 230 V / 50 Hz
- Heating elements: 1000 W
- Electronic temperature regulation: 30 – 250°C
- Top plate made of aluminium
- Required air pressure 8 – 10 bar
- Automatic opening
- Two moving plates with silicone padding
- Board dimensions 38 x 38 cm

## 8. SPOTTING EQUIPMENT

80015K	<b>WA-15 (vacuum)</b>	1950 €	<input type="checkbox"/>
--------	-----------------------	--------	--------------------------



**Available board**

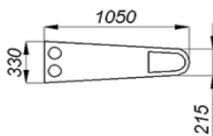

### Cold spotting table – standard equipment

- Air vacuum with mounted carbon filter
- Two cold spotting guns hanged on metal arm
- Two soap tanks
- Spotting arm
- Fan power 280W
- Board made of INOX
- Perfect board draining system
- Power supply: 230 V / 50 Hz
- Motor fan power: 280 W

### Additional options

80067	Lighting	107 €	<input type="checkbox"/>
70018B	Automatic steam generator ready to connect air-steam gun	1210 €	<input type="checkbox"/>
70048AS	Steam generator OLA Inox ready to connect air-steam gun	671 €	<input type="checkbox"/>
800456	Air - steam output for gun (external steam supply)	215 €	<input type="checkbox"/>
01520	Air - steam gun	95 €	<input type="checkbox"/>
80130	Pressure soap tank for brush or for soap gun	640 €	<input type="checkbox"/>
01585	Air gun	59 €	<input type="checkbox"/>

80015S	<b>WA-15/1 (vacuum)</b>	760,00 €	<input type="checkbox"/>
--------	-------------------------	----------	--------------------------



Available board

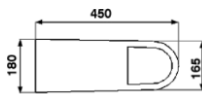

**Spotting Form** with vacuum. Compact table recommended to small dry cleaners shops.

- Power supply: 230 V / 50 Hz
- Motor fan power: 280 W
- One cold spotting guns hanged on metal arm
- One soap tank

80018	<b>WA-16 (vacuum)</b>	4100 €	<input type="checkbox"/>
-------	-----------------------	--------	--------------------------



**Spotting cabin WA-16** is produced according with environmental rules in the World.

- Double carbon filter
- Top board made of perfect quality INOX
- Two cold spotting guns
- Two soap tanks
- Spotting arm
- Fan motor power: 2 x 370 W
- Lighting – led
- Vacuum steering by pedal or by switch
- Shelf for Pre-spotters
- Power supply: 230 V / 50 Hz

**Additional options**

80558	Small – additional spotting arm (two arms)	220,00 €	<input type="checkbox"/>
70018B	Automatic steam generator ready to connect air-steam gun	1210,00 €	<input type="checkbox"/>
800456	Air - steam output for gun (external steam supply)	260,00 €	<input type="checkbox"/>
01520	Air-steam gun	105,00 €	<input type="checkbox"/>
80130	Pressure soap tank for brush or for soap gun	640,00 €	<input type="checkbox"/>
01585	Air gun	65,00 €	<input type="checkbox"/>

## 9. BAGGING MACHINES

86004	<b>WA-22w</b> (hanging wall mounted model)	1230,00 €	<input type="checkbox"/>
86002	<b>WA-22s</b> (standing model)	1390,00 €	<input type="checkbox"/>



### Bagging machine

- Heating element: 100W
- Welding time regulation
- Cutting elements
- Welding time: 0 – 10s
- Max width of foil sleeve: 600mm
- Max tickness of foil sleeve: 0,05mm
- Power supply: 230 V / 50 Hz
- Two models: Hanging / Standing

86006	<b>WA-22p</b> (pneumatic)	2600 €	<input type="checkbox"/>
-------	---------------------------	--------	--------------------------



### Bagging machine – pneumatic version with automatic opening flap.

- Heating element: 100W
- Regulation welding time
- Cutting elements
- Welding time: 0 – 10s
- Max width of foil sleeve: 600mm
- Max tickness of foil sleeve: 0,05mm
- Power supply: 230 V / 50 Hz
- Two type: Hanging / Standing
- Required air pressure 6 – 8 bar

86001	<b>WA-21 (pneumatic)</b>	3050,00 €	<input type="checkbox"/>
-------	--------------------------	-----------	--------------------------



**The Bagging machine** to bagging garment in a foil by pneumatic system. It has welding and cutting elements on both sides (from the top and bottom) and a welding time regulation.

Upper part is equipped with cutting elements and welding elements

Lower part is equipped with welding element. Thanks to height regulation it is possible to change the length of pack

Two sections can work simultaneously or separately.

- Heating element: 2 x 100W
- Regulation welding time
- Cutting elements
- Welding time: 0 – 10s
- Max width of foil sleeve: 600mm
- Max tickness of foil sleeve: 0,05mm
- Power supply: 230 V / 50 Hz
- Required air pressure 6 – 8 bar

86018	<b>WA-23/1</b> (package size 600 x 600 mm)	1590,00 €	<input type="checkbox"/>
86021	<b>WA-23/1 + auxiliary plate</b> (package size 600 x 600 mm)	1790,00 €	<input type="checkbox"/>
86022	<b>WA-23/2 + auxiliary plate</b> (package size 600 x 800 mm)	1890,00 €	<input type="checkbox"/>
86022B	<b>WA-23/2 + auxiliary plate</b> (package size 600 x 1000 mm)	2190,00 €	<input type="checkbox"/>



**Horizontal bagging machine.** Board with regulation of height is made of inox.

Flap is opening automatically after welding time.

- Heating element: 450 W
- Regulation welding time
- Board regulation of height 0-10 cm
- Welding time: 0 – 20s
- Max width of foil sleeve: 600mm
- Max tickness of foil sleeve: 0,05mm
- Power supply: 230 V / 50 Hz
- Depth adjustment of package 400-600mm (only for versions with auxiliary plate)

## 10. STEAM GENERATORS

70010A	<b>WA-40 A</b> (12 kW, 15.5 kg/h, 21 L, 7 bar)	3290,00 €	<input type="checkbox"/>
70010B	<b>WA-40 B</b> (15 kW, 20.0 kg/h, 28 L, 7 bar)	3990,00 €	<input type="checkbox"/>
70010C	<b>WA-40 C</b> (18 kW, 24.0 kg/h, 28 L, 7 bar)	3990,00 €	<input type="checkbox"/>
70010D	<b>WA-40 D</b> (21 kW, 27.5 kg/h, 28 L, 7 bar)	4100,00 €	<input type="checkbox"/>
70010E	<b>WA-40 E</b> (24 kW, 31.0 kg/h, 33 L, 6 bar)	4600,00 €	<input type="checkbox"/>
70010F	<b>WA-40 F</b> (30 kW, 40.0 kg/h, 33 L, 6 bar)	4600,00 €	<input type="checkbox"/>
70010G	<b>WA-40 G</b> (36 kW, 40.0 kg/h, 39 L, 5 bar)	4900,00 €	<input type="checkbox"/>



Version with condensate tank

**The steam generator** with the impeller pump and an automatic regulation of a water level.

The steam boiler is manufactured of stainless steel. It is also available as version with the stainless steel housing

**It has complete CE certification**

- Power supply: 400 V / 50 Hz
- Pump power: 500 W
- Max working pressure: 6 bar
- Heating elements: 12 / 15 / 18 / 21 / 24 / 30 kW
- Boiler capacity 18 / 21 / 28 / 33 L
- Efficiency: 16 / 20 / 24 / 27 / 32 / 40 kg/h
- Weight 54 kg
- Dimensions 750 x 600 x 950 cm

**Additional options**

88403A	Body made of INOX	460,00 €	<input type="checkbox"/>
70053	Condensate tank 75L made of INOX	470,00 €	<input type="checkbox"/>
	Built-in HEMI touch panel with PLC controller – advanced device control, remote diagnosis.	1350,00 €	<input type="checkbox"/>
<b>70081</b>	Set of heavy-duty swivel polyamide wheels, including 2 wheels with brakes.	140,00 €	<input type="checkbox"/>

70012B	<b>WA-40/2 B</b> (42 kW, 54.0 kg/h, 2 x 28 L, 7 bar)	7400,00 €	<input type="checkbox"/>
70012C	<b>WA-40/2 C</b> (48 kW, 62.0 kg/h, 2 x 33 L, 6 bar)	7650,00 €	<input type="checkbox"/>
70012D	<b>WA-40/2 D</b> (60 kW, 78.0 kg/h, 2 x 33 L, 6 bar)	7650,00 €	<input type="checkbox"/>



**The steam generator** with Two independent boilers with two impeller pumps and an automatic regulation of a water level.

The steam boiler is manufactured of a stainless steel. It is also available version with the stainless steel cover.

#### Has complete certification

- Power supply: 400 V / 50 Hz
- Pump power: 2 x 500 W
- Max Working pressure: 6 bar
- Heating elements: 36 / 42/ 48 / 60 kW
- Boiler capacity: 2x 28 L / 2 x 33 L

#### Additional Options

88403/2	Body made of INOX	500,00 €	<input type="checkbox"/>
70055	Condensate tank 120 L made of INOX	520,00 €	<input type="checkbox"/>



70011A	<b>WA-40/1 A</b> (15 kW, 20.0 kg/h, 28 L, 7 bar)	4900 €	<input type="checkbox"/>
70011B	<b>WA-40/1 B</b> (18 kW, 24.0 kg/h, 28 L, 7 bar)	4900 €	<input type="checkbox"/>
70011C	<b>WA-40/1 C</b> (21 kW, 27.5 kg/h, 28 L, 7 bar)	4990 €	<input type="checkbox"/>
70011D	<b>WA-40/1 D</b> (24 kW, 31.0 kg/h, 33 L, 6 bar)	5490 €	<input type="checkbox"/>
70011E	<b>WA-40/1 E</b> (30 kW, 35.0 kg/h, 33 L, 6 bar)	5490 €	<input type="checkbox"/>



**The steam generator** with the impeller pump and an automatic regulation of a water level.

The steam boiler is manufactured of a stainless steel. It is also available as version with the stainless steel housing  
 Condensate tank is built-in on standard version

#### It has complete CE certification

- Power supply: 400 V / 50 Hz
- Pump power: 500 W
- Max working pressure: 6 bar
- Heating elements: 18 / 21 / 24 / 30 kW
- Boiler capacity: 21 / 28 / 33 L

#### Additional equipment

88403	Stainless steel body	500 €	<input type="checkbox"/>
70066	Condensate tank heating (heating element 4,5 kW and cover of condensate tank)	325 €	<input type="checkbox"/>

70012E	<b>WA-40/2 E</b> (48 kW, 62.0 kg/h, 2 x 33 L, 6 bar)	9390,00 €	<input type="checkbox"/>
70012F	<b>WA-40/2 F</b> (60 kW, 78.0 kg/h, 2 x 33 L, 6 bar)	9390,00 €	<input type="checkbox"/>
70012H	<b>WA-40/3 G</b> (126 kW 163 kg/h, 2 x 39 L, 5 bar)	13200,00 €	<input type="checkbox"/>
70012GG	<b>WA-40/2 G</b> (84 kW, 110kg/h, 2 x 39 L, 5 bar)	9690,00 €	<input type="checkbox"/>



**Steam generator** with two/three self-contained boilers, integrated impeller pumps and automatic water intake system. It has steam boilers and feed water tank made of acid-resistant steel. It has current protection for heating and control elements and a working time counter.

The device is protected against water shortage both in the water tank and in the steam boiler.

The water tank (condensate) is equipped with a water level regulator as standard (brass float valve), tap 1/2", overflow and outflow 1/2", condensate connection 1/2" and also condensate cooling system.

The device requires softened water with a maximum temperature of 70°C for operation.

Steam generator WA-40/2 meets all safety standards, has CE and UDT certificates of conformity

#### It has complete certification CE

- Power supply: 400 V / 50 Hz
- Pump power: 500 W each (2 or 3)
- Max Working pressure: 6 bar (WA-40/2 E,F)
- Max Working pressure: 5 bar (WA-40/3 G, WA-40/2 G)
- Heating elements: 48 / 60 kW
- Boiler capacity: 33 L / 39 L (depends of model)

#### Additional options

88403/2	Body made of INOX WA-40/2	590,00 €	<input type="checkbox"/>
88403/3	Body made of INOX WA-40/3	790,00 €	<input type="checkbox"/>
70066	Condensate tank heating (heating element 4,5 kW and cover of condensate tank)	325,00 €	<input type="checkbox"/>

70009D

**WA-48/5 Steam Generator low pressure****6600,00 €**

Steam generator for vaporization of wood with an automatic water intake system. Available with and without a water pump - for mains water. It has a steam boiler made of acid-resistant steel. The device requires softened water for operation.

OLA steam generator equipped with an acid resistant steel steam tank and 1.5kW or 2kW heating elements. Version for manual adding water.

It has an adjustable steam solenoid valve, manometer and a holder for suspending the wires of an iron or a gun.

Equipped with an acoustic signaling device informing about the ending water level in the steam boiler.

OLA buzzer is an ideal solution for companies that provide services at the customer's premises using ironing devices.

Super resistant to shocks during transport and work in demanding conditions

OLA steam generator with air-steam gun has two regulated solenoid valves. Ending water level beep.

The device requires softened water for operation.

**Technical data:**

- Power supply: 400 V / 50 Hz
- Steam generator heating elements power: 30 kW
- Boiler capacity: 72 L
- Working pressure: 0,20 – 0,45 bar (to set)
- Maksimum pressure PS: 0,5 bar

70013A	<b>WA-44</b> (two solenoid valve, 4.2 kW, 4.5 bar, 7.2 L)	1450,00 €	<input type="checkbox"/>
70013	<b>WA-44</b> (two solenoid valve, 4.2 kW, 4.5 bar, 7.2 L, Inox tank)	1520,00 €	<input type="checkbox"/>
70013A	<b>WA-44</b> (two solenoid valve, 6 kW, 4.5 bar, 7.2 L)	1520,00 €	<input type="checkbox"/>
70013AP	<b>WA-44</b> (two solenoid valve, 6 kW, 4.5 bar, 7.2 L Inox tank)	1650,00 €	<input type="checkbox"/>



The steam generator with the impeller pump and water level automatic regulation.

Equipped with built-in water tank made of Inox.

Easy access thanks to front door.

The steam boiler is manufactured of a stainless steel.

It has complete CE certification

**Manufacturer – ALUX**

#### Technical data

- Power supply: 400 V / 50 Hz
- Pump power: 500 W
- Max Working pressure: 4,5 bar
- Heating elements: 4,2 kW / 6,0 kW
- Boiler capacity 7,2 L
- Solenoid valve with regulation – 2 pcs
- Weight: 54 kg
- Dimensions: 36 x 48 x 94cm

70014	<b>WA-44/1</b> (one solenoid valve, 3 kW, 3.5 bar, 7.2 L)	1190,00 €	<input type="checkbox"/>
70015A	<b>WA-44/2</b> (two solenoid valve, 4.2 kW, 3.5 bar, 7.2 L)	1300,00 €	<input type="checkbox"/>
70015B	<b>WA-44/2</b> (two solenoid valve, 6 kW, 3.5 bar, 7.2 L)	1390,00 €	<input type="checkbox"/>



WA-44/2

**The steam generator** with the impeller pump and water level automatic regulation. Equipped with water tank built-in.

The steam boiler is manufactured of stainless steel.

**It has complete CE certification**

**Manufacturer – ALUX**

#### Technical data

- Power supply: 400 V / 50 Hz
- Pump power: 370 W
- Max working pressure: 4,5 bar
- Heating elements: 3 / 4,2 kW
- Boiler capacity: 7,2 L
- Solenoid valve with regulation: 1/2 pcs
- Efficiency: 3,9 / 5,4 kg/h
- Weight: 44 kg
- Dimensions: 40 x 40 x 84cm

70016	<b>WA-44/3</b> (three solenoid valve, 6 kW, 4.5 bar, 9.8 L)	1590,00 €	<input type="checkbox"/>
70017	<b>WA-44/4</b> (four solenoid valve, 8.4 kW, 4.5 bar, 9.8 L)	1790,00 €	<input type="checkbox"/>



WA-44/3

**The steam generator** with the impeller pump and an automatic regulation of water level.

The steam boiler is manufactured of stainless steel.

Ready to work with three (WA-44/3) or four (WA-44/4) devices.

**It has complete certification CE  
Manufacturer – ALUX**

#### Technical data

- Power supply: 400 V / 50 Hz
- Pump power: 500 W
- Max working pressure: 4,5 bar
- Heating elements: 6 / 8,4 kW
- Boiler capacity: 9,8 L
- Solenoid valve with regulation: 3/4 pcs
- Efficiency: 7,8 / 11 kg/h
- Weight: 59 kg
- Dimensions: 43 x 37 x 84cm

70018	<b>WA-45</b> (one solenoid valve, 2 kW, 4.5 bar, 4 L) INOX	1290,00 €	<input type="checkbox"/>
70018A	<b>WA-45</b> (one solenoid valve, 2 kW, 4.5 bar, 4 L) painted body	1290,00 €	<input type="checkbox"/>



**The steam generator** with the piston pump and an automatic regulation of a water level. Body and boiler is made of INOX or painted body (70018A)

Ready to work with one device.

**Manufacturer – ALUX**

#### Technical data

- Power supply: 230 V / 50 Hz
- Pump power: 48 W
- Max Working pressure: 5 bar
- Heating elements: 2 kW
- Boiler capacity 4 L
- Solenoid valve with regulation: 1 pcs
- Efficiency: 2,6 / 3,9 kg/h

#### Additional Options

80045A	Air - steam output for gun	140,00 €	<input type="checkbox"/>
09963	Painted in white metal stand with shelf for plastic tank 10 L	110,00 €	<input type="checkbox"/>
09963I	Inox metal stand with plastic tank 10 L	130,00 €	<input type="checkbox"/>

70048	<b>OLA</b> (one solenoid valve, 1.5 kW or 2 kW, 3.5 bar, 5 L)	490,00 €	<input type="checkbox"/>
70048A	<b>OLA inox</b> (one solenoid valve, 1.5 kW or 2 kW, 3.5 bar, 5 L)	490,00 €	<input type="checkbox"/>



**The steam generator** for manual refill of water. Equipped with a boiler made of INOX, heating element 2kW. Painted body. Ready to work with one item.

Equipped with flow regulation from steam outlet, pressure gauge, unbreakable water level pipe.

Voice alarm in case too low level water in boiler.

Soft water is recommended.

**Manufacturer – ALUX**

#### Technical data

- Power supply: 230 V / 50 Hz
- Max working pressure: 3,5 bar
- Heating elements: 1,5 kW or 2 kW
- Boiler capacity 5 L
- Solenoid valve with regulation: 1 pcs
- Efficiency: 1,9 – 2,6 kg/h

#### Additional Options

09963	Painted in white metal stand with shelf for plastic tank 10 L	110,00 €	<input type="checkbox"/>
09963I	Inox metal stand with shelf for plastic tank 10 L	130,00 €	<input type="checkbox"/>
<b>09964</b>	Stand with an iron shelf and space for a 10 L water tank.	130,00 €	<input type="checkbox"/>

70048EA	<b>Ola PLUS 1</b> (one steam output, 2 kW, 3.5 bar, 5 L) solenoid pump	<b>700,00 €</b>	<input type="checkbox"/>
70048E	<b>Ola PLUS 2</b> (one steam output, 2 kW, 3.5 bar, 5 L) rotation pump	<b>810,00 €</b>	<input type="checkbox"/>
70048EI	<b>Ola PLUS 2 INOX</b> (one steam output, 2 kW, 3.5 bar, 5 L) rotation pump body INOX	<b>860,00 €</b>	<input type="checkbox"/>



**The semiautomatic steam generator** equipped with a boiler made of INOX, heating element 2kW, impeller pump in version **Ola PLUS 2** or solenoid pump for **Ola PLUS 1**

Equipped with flow regulation from steam outlet, pressure gauge, unbreakable water level pipe.

Voice alarm in case too low level water in boiler.

Soft water is recommended.

**Manufacturer – ALUX**

#### Technical data

- Power supply: 230 V / 50 Hz
  - Max working pressure: 3,5 bar
  - Heating elements: 2 kW
  - Impeller pump power: 370 W
  - Solenoid pump power: 48 W
  - Boiler capacity: 5 L
  - Solenoid valve with regulation: 1 pcs
- Efficiency: 2,6 kg/h

70048H

**OLA Automat** one solenoid valve for steam, 2 kW, 3.5 bar, 5L

**810,00 €**



**The steam generator** with automatic refill of water. Equipped with a boiler made of INOX, heating element 2kW. Painted body. Ready to work with one item.

Equipped with flow regulation from steam outlet, pressure gauge, unbreakable water level pipe.

Voice alarm in case too low level water in boiler.

Soft water is recommended.

**Manufacturer – ALUX**

#### Technical data

- Power supply: 230 V / 50 Hz
  - Max working pressure: 3,5 bar
  - Heating elements: 2 kW
  - Pump power: 48 W
  - Boiler capacity: 5 L
  - Solenoid valve with regulation: 1 pcs
- Efficiency: 2,6 kg/h

70001A

**Mila Steam generator painted white** (one steam output 2,5L, 1kW, 3 bar)

**330 €**



**Mila steam generator equipped** with steam boiler made of stainless steel and 1kW heating elements, an adjustable steam solenoid valve, the holder for hanging iron or gun wires

Mila device needs manual water refills.

It is recommended to fill the steam generator boiler with softened water.

#### Manufacturer – ALUX

#### Tecnicl data

- Power supply: 230 V / 50 Hz
- Power of boiler heating elements: 1,5 kW
- Boiler capacity: 2,5 L
- Number of electro-steam outputs: 1
- Working pressure: 3 bar

70001

**Mila Inox steam generator** (one steam output, housing made of inox, 2,5L, 1kW, 3 bar)

**330 €**



**Mila Inox steam generator equipped** with housing and boiler made of stainless steel, 1kW heating elements, an adjustable steam solenoid valve, a holder for hanging iron or gun wires

Mila device needs the manual water refills.

It is recommended to fill the steam generator boiler with softened water.

#### Manufacturer – ALUX

#### Tecnicl data

- Power supply: 230 V / 50 Hz
- Power of boiler heating elements: 1kW
- Boiler capacity: 2,5 L
- Number of electro-steam outputs: 1
- Working pressure: 3 bar



## 11. ADDITIONAL EQUIPMENT

02102	<b>WA-50</b> (for air-steam gun)	260,00 €	<input type="checkbox"/>
02100	<b>WA-50/1</b> (for industrial iron)	220,00 €	<input type="checkbox"/>
02101	<b>WA-50/2</b> (for two industrial irons)	270,00 €	<input type="checkbox"/>

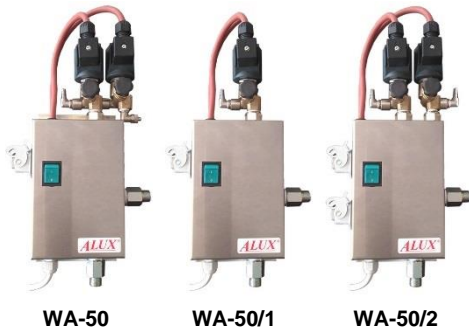
**Steam condenser to connect irons to the central steam supply**

Made of inox

- Power supply: 230 V / 50 Hz
- Solenoid valve with regulation
- Thread diameter: G 3/8"

80040	<b>WA-60</b>	550,00 €	<input type="checkbox"/>
-------	--------------	----------	--------------------------







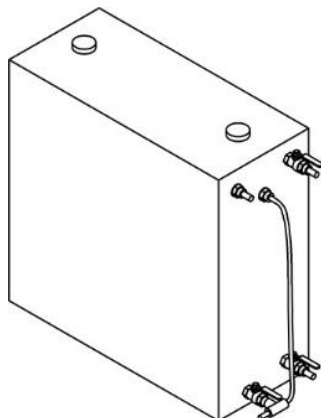

The Steam Heater – recommended when the steam hoses exceed 3,5 m in length.

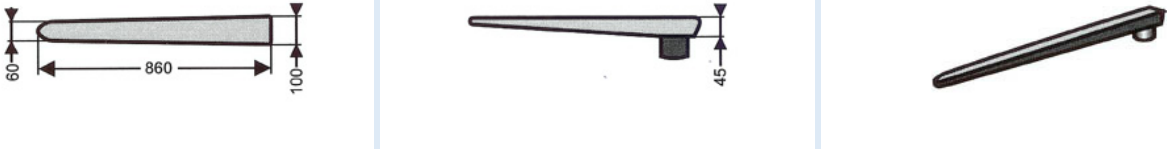
**Condensate Tank**

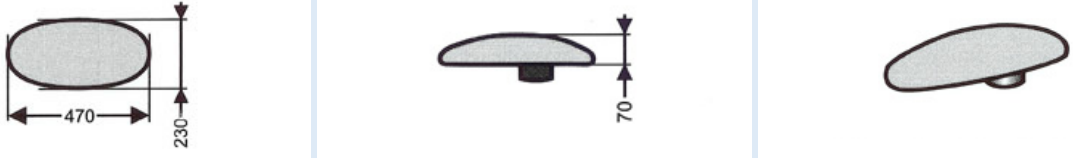
70046	▪ For tables WA-9, WA-17 (17L)	230,00 €	<input type="checkbox"/>
70064	▪ For tables WA-8, WA-10N (15L)	230,00 €	<input type="checkbox"/>
	▪ Customised condensate tank	On request	

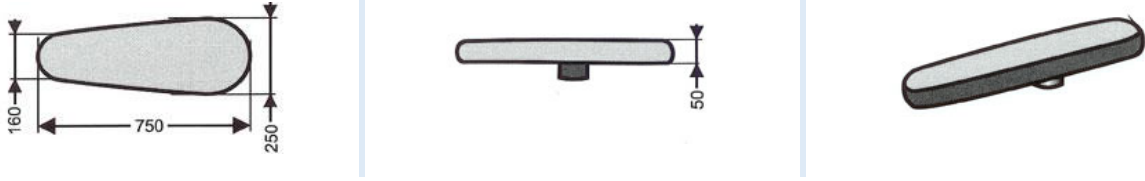
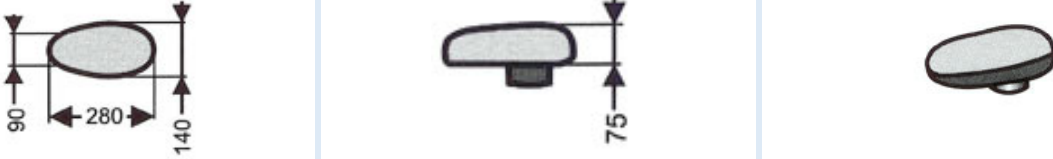

**Condensate** tank made of INOX, equipped with water float valve, ball valve and condensate return line

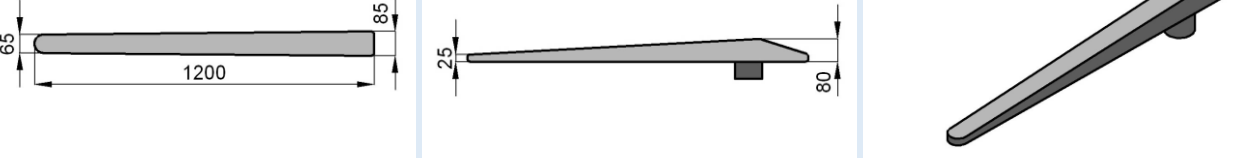
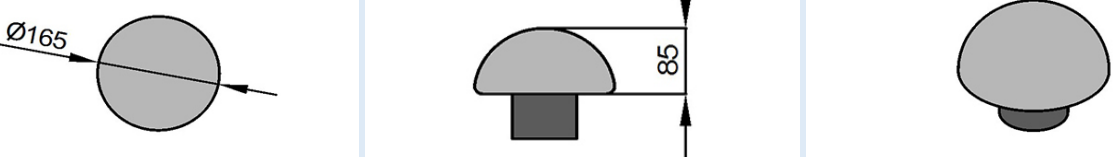
80021	<b>WA-101</b> Universal shape, (heating elements 100 W + safety thermostat)	130,00 €	<input type="checkbox"/>
			
80022	<b>WA-102</b> Universal shape, (heating elements 100 W + safety thermostat)	140,00 €	<input type="checkbox"/>
			
80023	<b>WA-103</b> for seams and for sleeve (heating elements 100 W + safety thermostat)	160,00 €	<input type="checkbox"/>
			
80024	<b>WA-104</b> Universal form, (heating elements 200 W + safety thermostat)	170,00 €	<input type="checkbox"/>
			
80025	<b>WA-105</b> for skirts and Bermuda, (heating elements 200 W + safety thermostat)	230,00 €	<input type="checkbox"/>
			

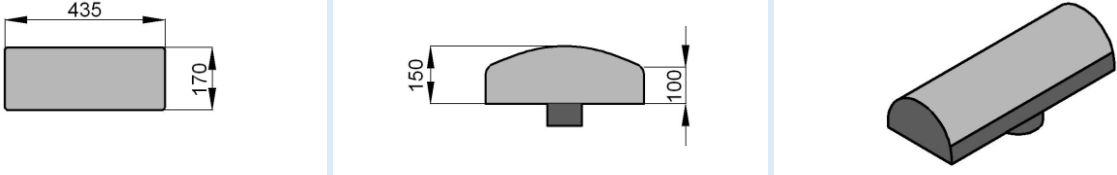
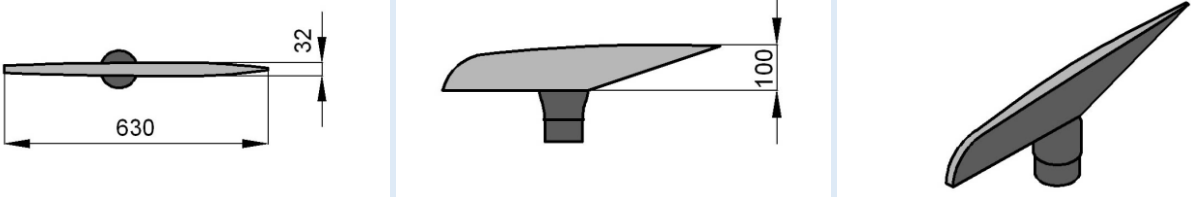
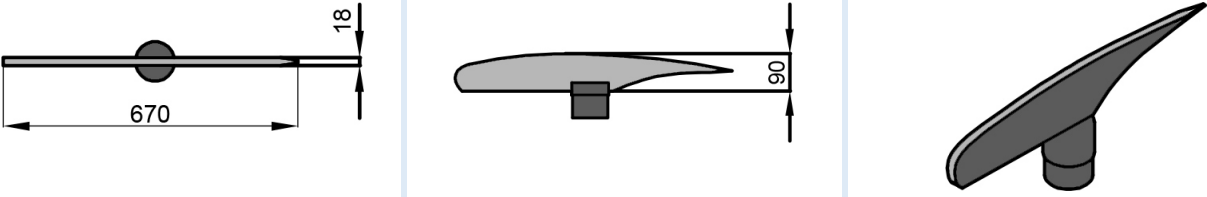
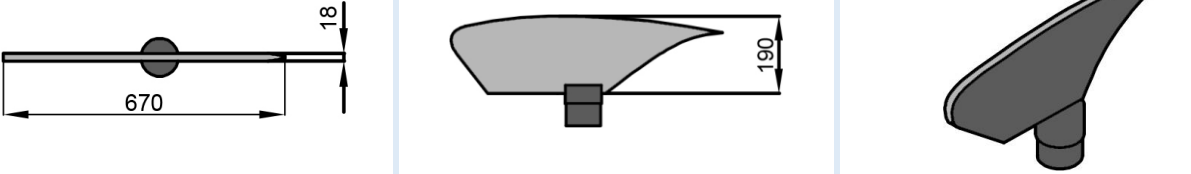
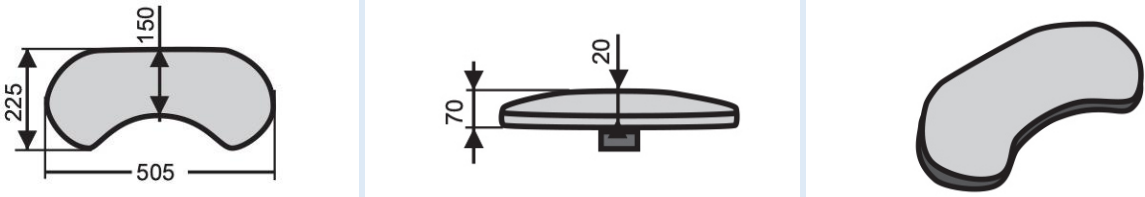
80026	<b>WA-106</b> Universal form for jacket, coat (heating elements 200 W + safety thermostat)	225,00 €	<input type="checkbox"/>
			
80027	<b>WA-107</b> for „head” of sleeve, no heated	115,00 €	<input type="checkbox"/>
			
80028	<b>WA-108</b> Trousers seam-opening shape (heating elements 100 W + safety thermostat)	175,00 €	<input type="checkbox"/>
			
80029	<b>WA-109</b> Universal ironing form, for ironing table WA-7, Ecomatic (heating elements 100 W + safety thermostat)	140,00 €	<input type="checkbox"/>
			
80030	<b>WA-110</b> Trousers seam-opening shape (heating elements 200 W + safety thermostat)	220,00 €	<input type="checkbox"/>
			
80031	<b>WA-111</b>	135,00 €	<input type="checkbox"/>
			

80032	<b>WA-112</b> Jacket ironing shape (heating elements 200 W + safety thermostat)	220,00 €	<input type="checkbox"/>
			
80033	<b>WA-113</b> Seam-ironing ironing shape (stainless steel body, without heating element)	350,00 €	<input type="checkbox"/>
			
80033/4	<b>WA-113/4</b> Seam-ironing ironing shape (stainless steel body, without heating element)	350,00 €	<input type="checkbox"/>
			
80033/5	<b>WA-113/5</b> Seam-ironing ironing shape (stainless steel body, without heating element)	350,00 €	<input type="checkbox"/>
			
80034	<b>WA-114</b> Jacket ironing shape (heating elements 100 W + safety thermostat)	330,00 €	<input type="checkbox"/>
			

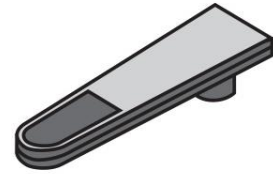
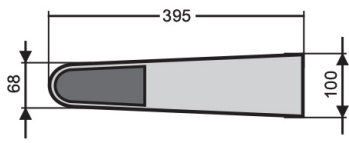
80035	<b>WA-115</b> Spotting form made of INOX	210,00 €	<input type="checkbox"/>
-------	--	----------	--------------------------



80036	<b>WA-116</b> Shoulder ironing shape	200,00 €	<input type="checkbox"/>
-------	--------------------------------------	----------	--------------------------

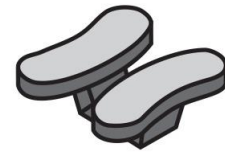
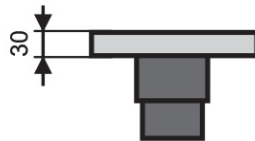
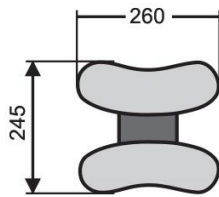

80037	<b>WA-117</b> Sleeve ironing shape (heating elements 100 W + safety thermostat)	140,00 €	<input type="checkbox"/>
-------	--	----------	--------------------------

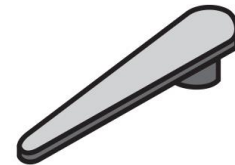
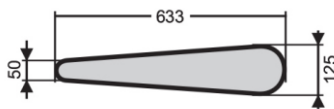

80037A	<b>WA-117A</b> Sleeve ironing shape (heating elements 100 W + safety thermostat)	150,00 €	<input type="checkbox"/>
--------	---	----------	--------------------------

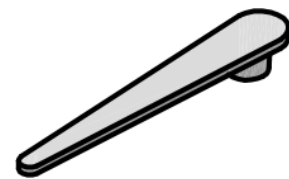
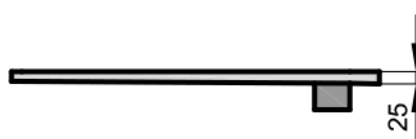
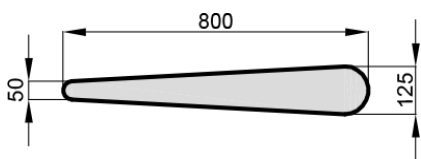

80039	<b>WA-118</b> Collars ironing shape (heating elements 200 W + safety thermostat)	170,00 €	<input type="checkbox"/>
-------	---	----------	--------------------------

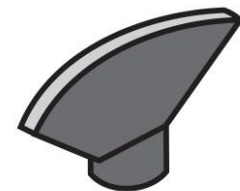
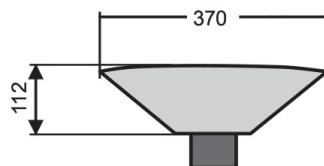
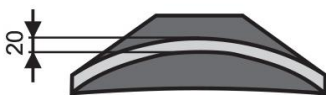

80043	<b>WA-120</b>	170,00 €	<input type="checkbox"/>
-------	---------------	----------	--------------------------

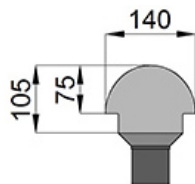
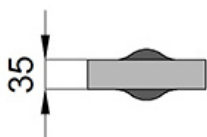

80043B	<b>WA-122/1</b> (heating elements 100 W + safety thermostat)	520,00 €	<input type="checkbox"/>
--------	---	----------	--------------------------

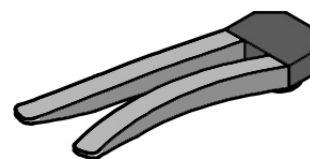
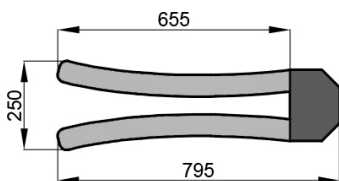

80043C	<b>WA-123</b> (heating elements 100 W + safety thermostat)	210,00 €	<input type="checkbox"/>
--------	--	----------	--------------------------

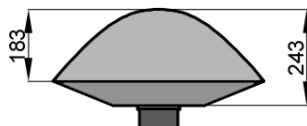
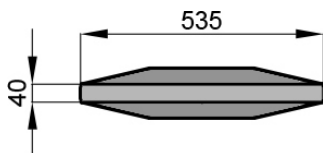

80043D	<b>WA-124</b> (heating elements 100 W + safety thermostat)	310,00 €	<input type="checkbox"/>
--------	--	----------	--------------------------

